

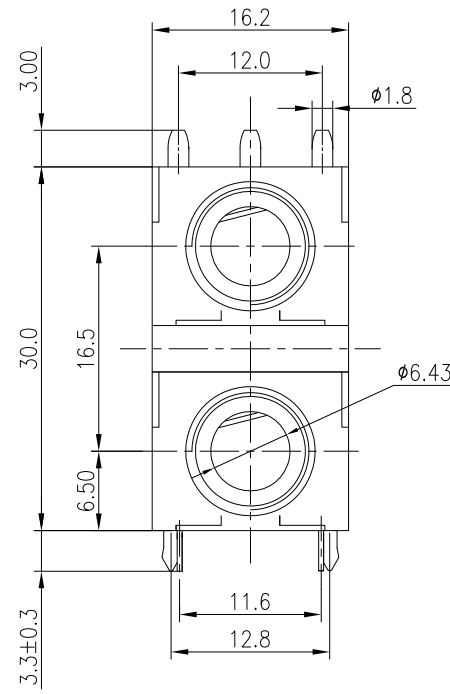

REV.	ECN NO.	MODIFIED MARK	APPROVED
A	—	FIRST RELEASE	

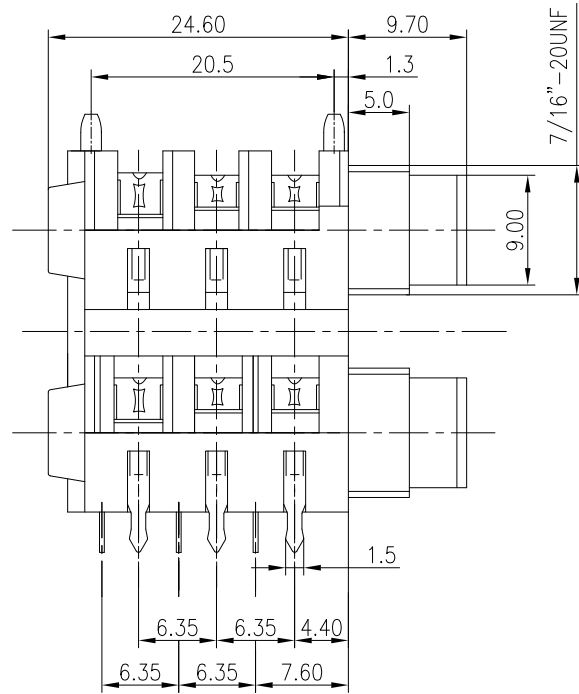

NOTES:
 ELECTRICAL:
 1:RATED CURRENT: 1A Max.
 2:RATED VOLTAGE: 50V AC.
 3:CONTACT RESISTANCE: 100 MILLIOHMS Max.
 AFTER TESTING:100 MILLIOHMS Max.
 4:INSULATION RESISTANCE: 100 MEGAOHMS Min.
 5:DIELECTRIC WITHSTANDING VOLTAGE: 500 VAC Min.
 MECHANICAL:
 1:INSERTION FORCE: 5N-40N.
 2:WITHDRAWAL FORCE: 5N-40N.
 3:DURRABILITY: 5000 CYCLES.
 ENVIRONMENTAL:
 TEMPERATURE RANGE: -20°C TO 60°C.

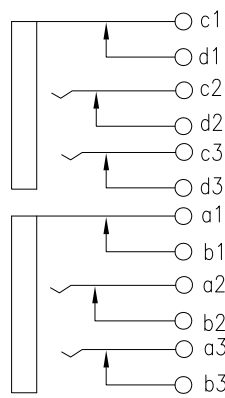
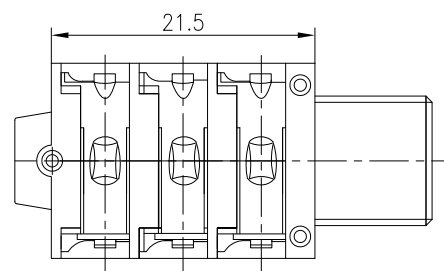
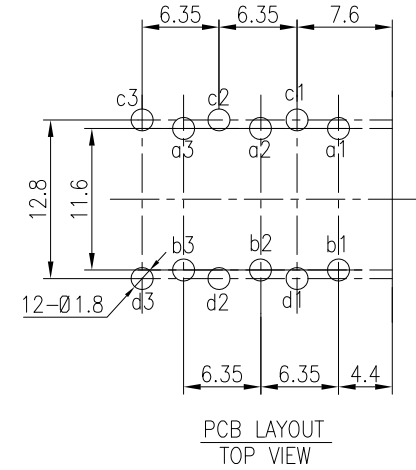

SCHEMATIC

ANGLE	$\pm 5^\circ$	MODEL NAME: SJ6337H	 广东正宝科技有限公司 GUANGDONG TRENPRO TECHNOLOGY CO. LTD.	
$63 < L$	± 0.5	(PART NO.)		
$16 < L \leq 63$	± 0.4	MAT'L:	DESIGN: Z.F.Lian 08/28'18	TITLE: 6.35 PHONE JACK
$4 < L \leq 16$	± 0.3	See table		
$L \leq 4$	± 0.2	FINISH:	CHECKED: L.W.Wu 08/28'18	DWG NO.:
TOL TABLE:		See table		REV.: A
THIS DOCUMENT IS THE PROPERTY OF TRENPRO TECHNOLOGY CO. LTD.,LTD.,NO PART THEREOF MAY BE REPRODUCED AND USED WITHOUT THE PRIOR WRITTEN CONSENT OF THE OWNER		Q'TY: /	APPROVED: X.Q.Hu 08/28'18	UNIT: mm
			VIEW: 	SCALE: 5:1
				SHEET: 1/1
				SIZE: A3