

REV.	ECN NO.	MODIFIED MARK	APPROVED
A	—	FIRST RELEASE	

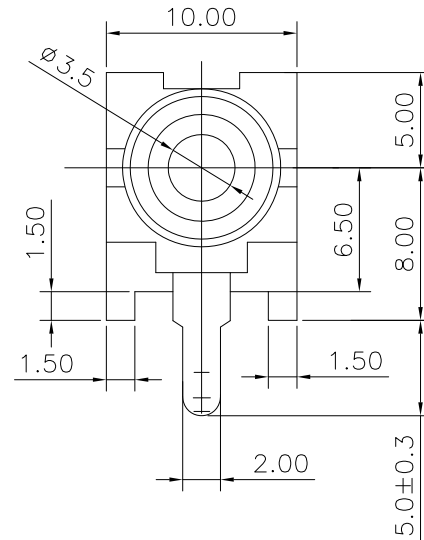

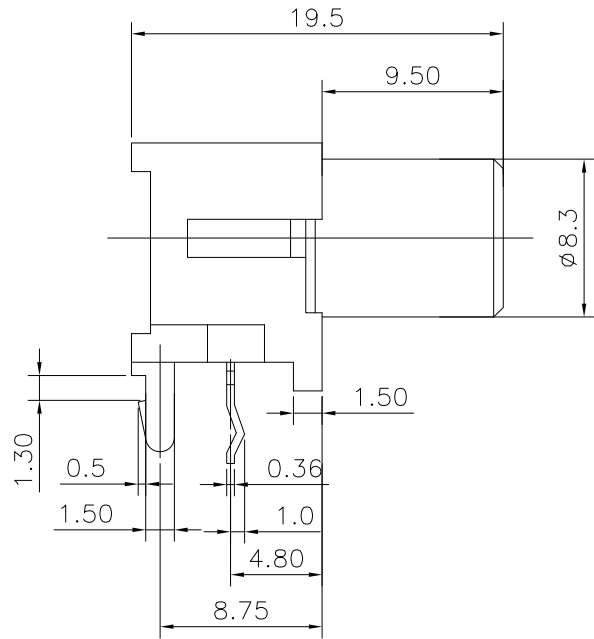

NOTES:  
 ELECTRICAL:  
 1:RATED CURRENT: 0.2A Max.  
 2:RATED VOLTAGE: 50V AC.  
 3:CONTACT RESISTANCE: 30 MILLIOHMS Max.  
 AFTER TESTING:100 MILLIOHMS Max.  
 4:INSULATION RESISTANCE: 100 MEGAOHMS Min.  
 5:DIELECTRIC WITHSTANDING VOLTAGE: 500 VAC Min.  
 MECHANICAL:  
 1:INSERTION FORCE: 3N-30N.  
 2:WITHDRAWAL FORCE: 3N-30N.  
 3:DURRABILITY: 100 CYCLES.  
 ENVIRONMENTAL:  
 TEMPERATURE RANGE: -20°C TO 60°C.

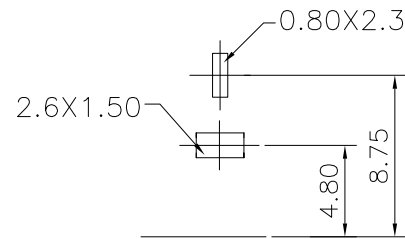

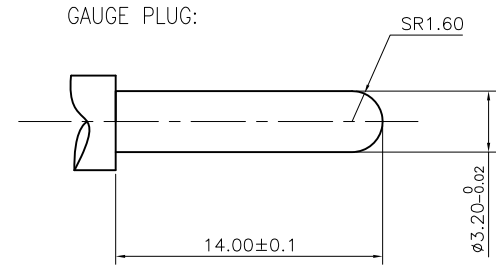
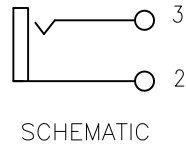
PCB LAYOUT  
TOP VIEW



ANGLE	±5°	MODEL NAME: RCA-105A (PART NO.)	 广东正宝科技有限公司 GUANGDONG TRENPRO TECHNOLOGY CO. LTD.					
63 < L	±0.5							
16 < L ≤ 63	±0.4		MAT'L: See table	DESIGN: X.H.Wang 11/06'18	TITLE: RCA PIN JACK			
4 < L ≤ 16	±0.3		FINISH: See table	CHECKED: L.W.Wu 11/06'18	DWG NO.:			
L ≤ 4	±0.2		Q'TY: /	APPROVED: X.Q.Hu 11/06'18	UNIT: mm	VIEW: 	SCALE: 5:1	SHEET: 1/1
TOL TABLE:		THIS DOCUMENT IS THE PROPERTY OF TRENPRO TECHNOLOGY CO. LTD., NO PART THEREOF MAY BE REPRODUCED AND USED WITHOUT THE PRIOR WRITTEN CONSENT OF THE OWNER		REV.: A				